

# Tech. data: SAN 20/40-130

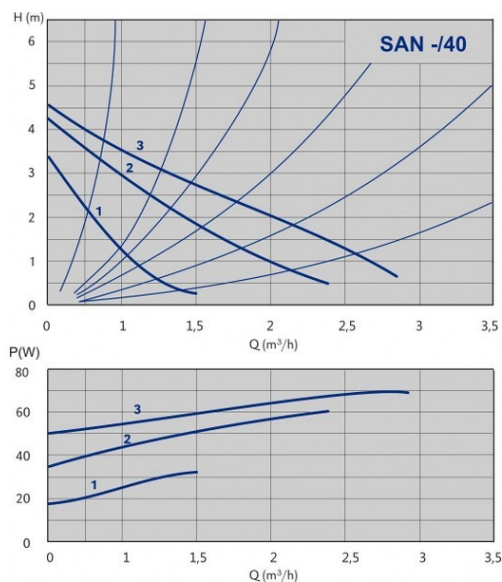

CODE: 979521766

## TECHNICAL DATA:

Q max: 2,8 m<sup>3</sup>/h  
H max: 3,9 m  
System pressure: PN 10 bar  
Nr. of speeds: 3

## ELECTRICAL PARAMETERS:

Power: 75 W  
Declared current: 0,17 - 0,33 A  
Power supply: 1 ~ 230 V  
Insulating class: H  
Degree of protection: IP 44

## INSTALLATION & MEDIUM:

Pipe connection: G 1 1/4 "  
Port-to-port length: 130 mm  
Liquid temperature range: +5 do +65 °C  
Environment temperature range: 0 do 40 °C  
Max. working pressure at 50/80/110°C: 0,05/0,4/1,1 bar

## MATERIALS:

Impeller material: noryl  
Housing material: bronze

## OTHERS:

Casing construction: single  
Net weight: 2,3 kg  
Gross weight: 2,4 kg  
Volume of packaging: 0,002842 m<sup>3</sup>

# Diagram and el. wiring: SAN 20/40-130

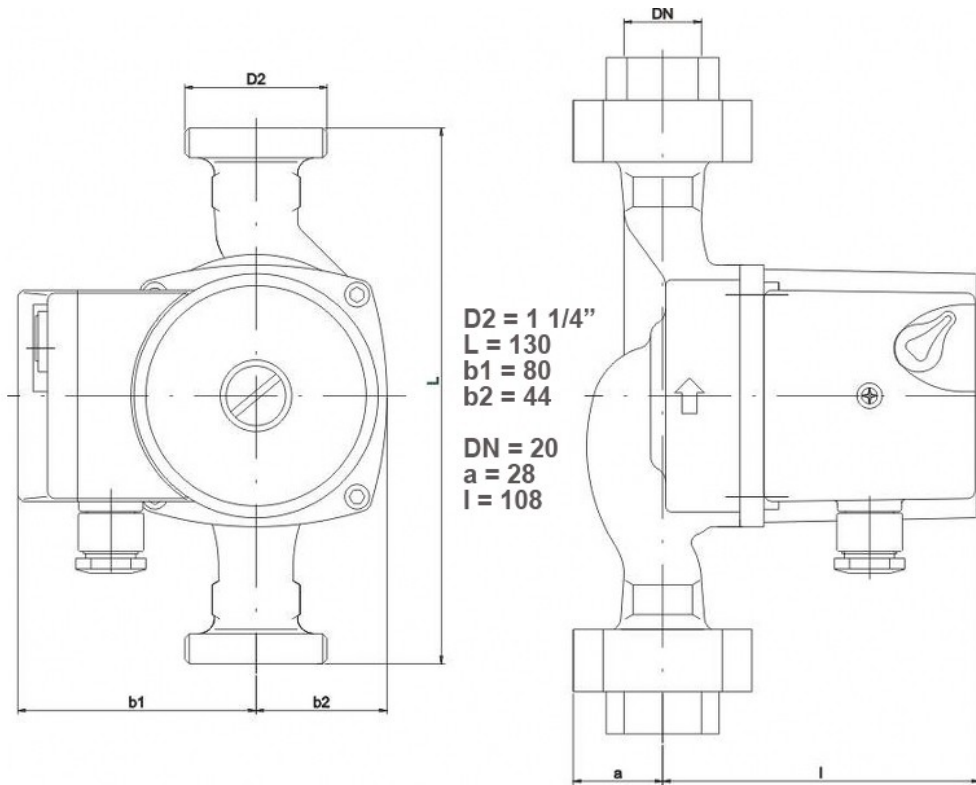

1

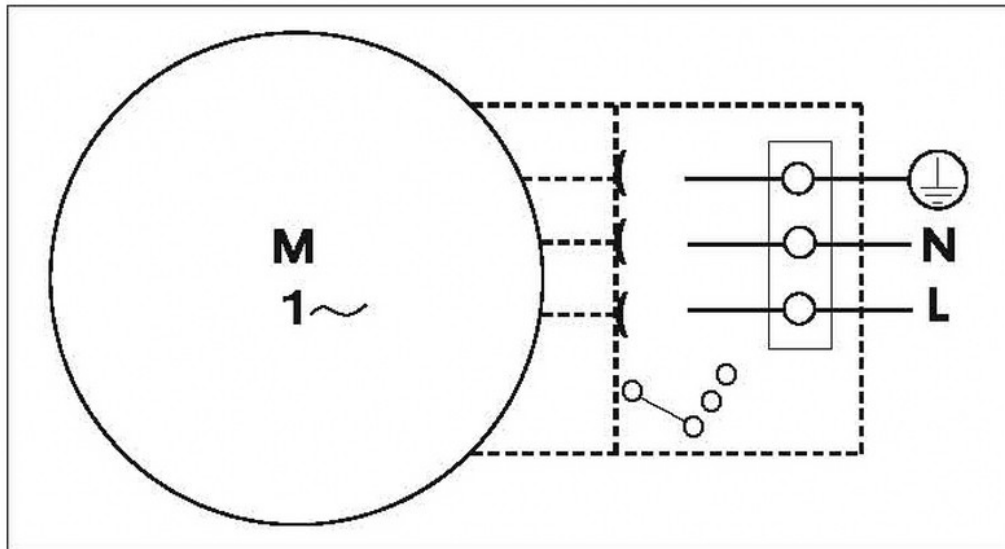

2