

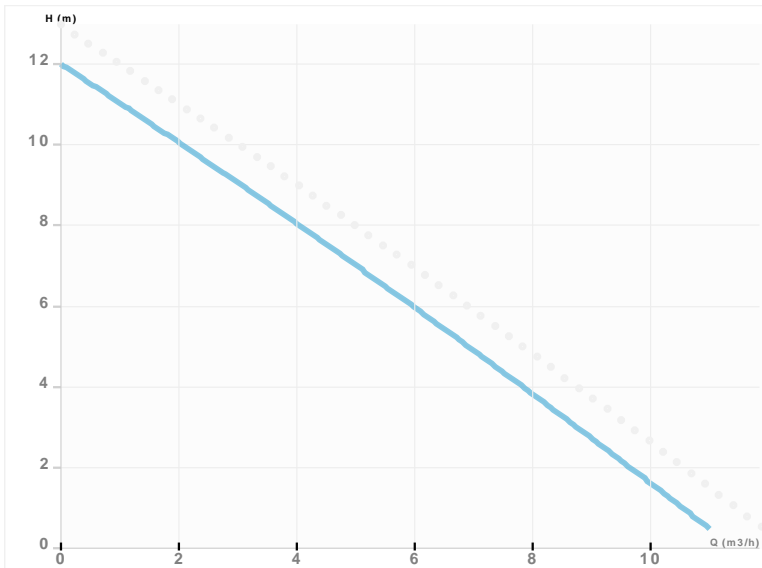

## NMT SMART C 50/120 F

NMT SMART C / Electronically regulated circulating pump - communication

Heating, Climatisation



Part number	<b>979524544</b>
Declared height	-
Power supply	<b>1 ~ 230V, 50Hz</b>
Declared protection	<b>IP 44 (IEC 144)</b>
Q max	<b>10.77 [m³/h]</b>
H max	<b>11.82 [m]</b>
RPM	<b>4800 [1/min]</b>
Motor power	<b>180.0 [w]</b>
Declared current	<b>0.1 [A]</b>
Fluid temperature	<b>2.0 ÷ 110.0 [°C]</b>
Insulation class	<b>F</b>
Casing construction	<b>Single casing</b>
DN1	<b>50 [mm]</b>
DN2	<b>50 [mm]</b>
Casing material	<b>Gray cast iron</b>
Connector	<b>PN6/10</b>
Weight	<b>0 [kg]</b>
Connectors position	<b>Inline (0°)</b>
Length	<b>240 [mm]</b>

Drawing

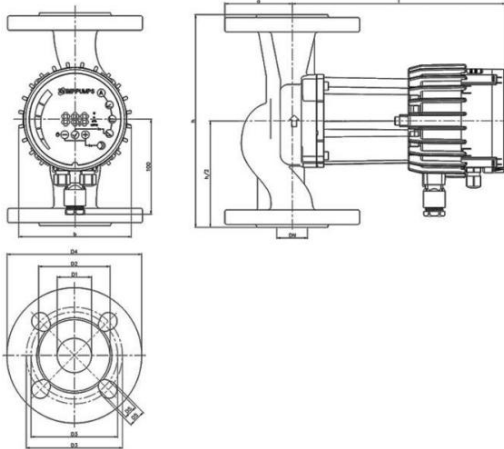

Sketch

