

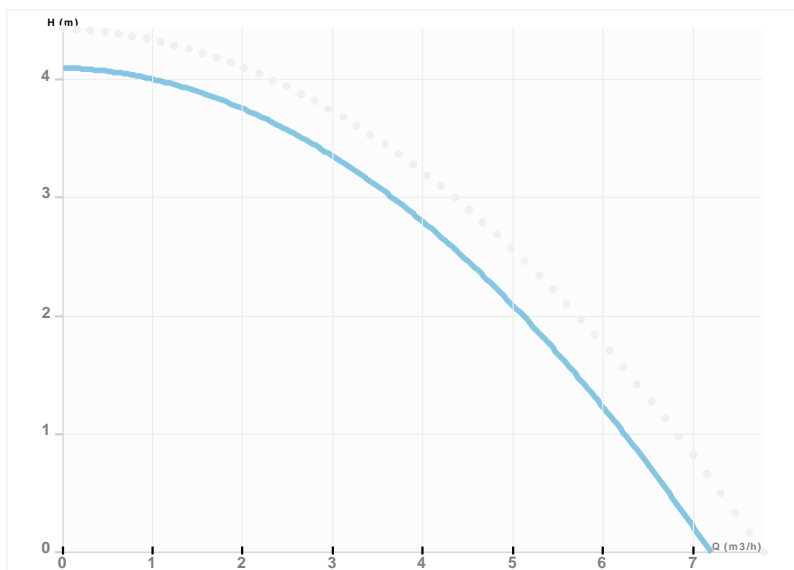

## NMT SMART C 40/40 F

NMT SMART C / Electronically regulated circulating pump - communication  
 Heating, Climatisation



Part number	<b>979523515</b>
Declared height	<b>PN6/10</b>
Power supply	<b>1 ~ 230V, 50Hz</b>
Declared protection	<b>IP 44 (IEC 144)</b>
Q max	<b>7.5 [m³/h]</b>
H max	<b>4.0 [m]</b>
RPM	<b>2800 [1/min]</b>
Motor power	<b>10-60 [w]</b>
Declared current	<b>0,1-0,5 [A]</b>
Fluid temperature	<b>2.0 ÷ 110.0 [°C]</b>
Insulation class	<b>H</b>
Casing construction	<b>Single casing</b>
DN1	<b>32 [mm]</b>
DN2	<b>32 [mm]</b>
Casing material	<b>Gray cast iron</b>
Connector	<b>PN6/10</b>
Weight	<b>8,7 [kg]</b>
Connectors position	<b>Inline (0°)</b>
Lenght	<b>220 [mm]</b>

Drawing

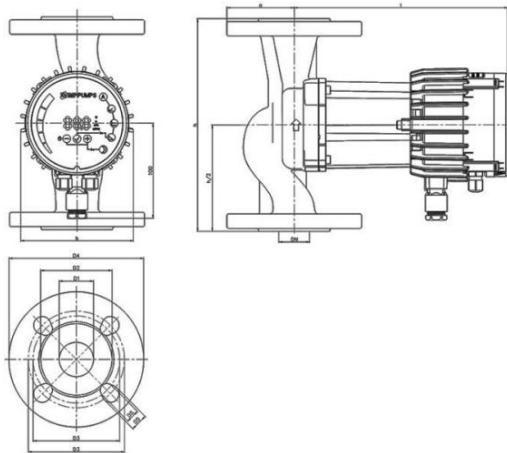

DN=40 h=220 a=75 l=222

Sketch

