

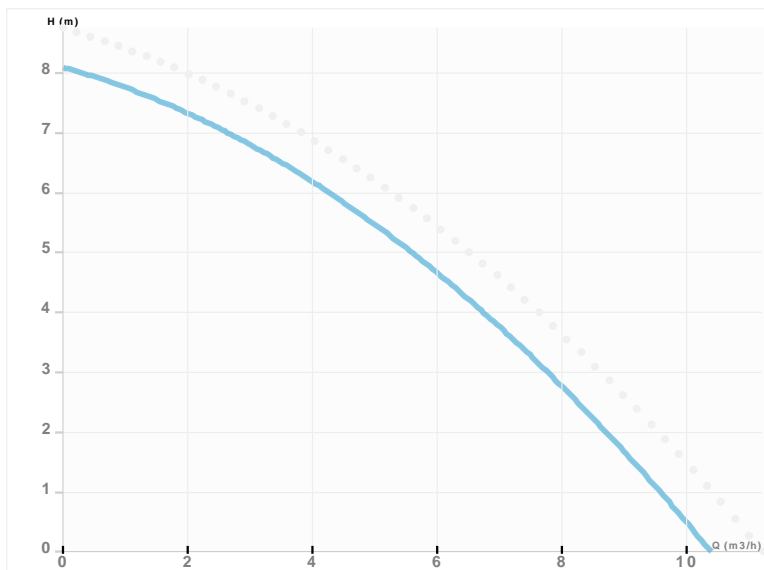

NMT SMART C 25/80

NMT SMART C / Electronically regulated circulating pump - communication
 Heating, Climatisation



Part number	979523495
Declared height	PN10
Power supply	1 ~ 230V, 50Hz
Declared protection	IP 44 (IEC 144)
Q max	10.0 [m³/h]
H max	8.0 [m]
RPM	4000 [1/min]
Motor power	10-140 [w]
Declared current	0,1-1,15 [A]
Fluid temperature	2.0 ÷ 110.0 [°C]
Insulation class	H
Casing construction	Single casing
DN1	25 [mm]
DN2	25 [mm]
Casing material	Gray cast iron
Connector	G 1 1/2"
Weight	4,2 [kg]
Connectors position	Inline (0°)
Length	180 [mm]

Drawing

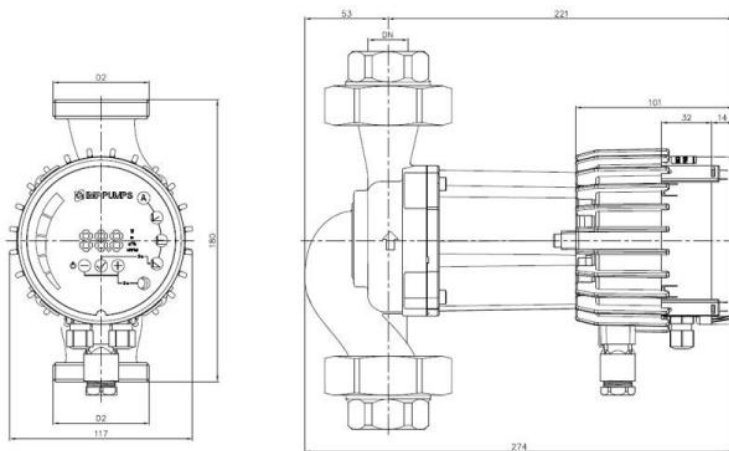

L=180 l=222 DN=25 D2=1 1/2"

Sketch

