

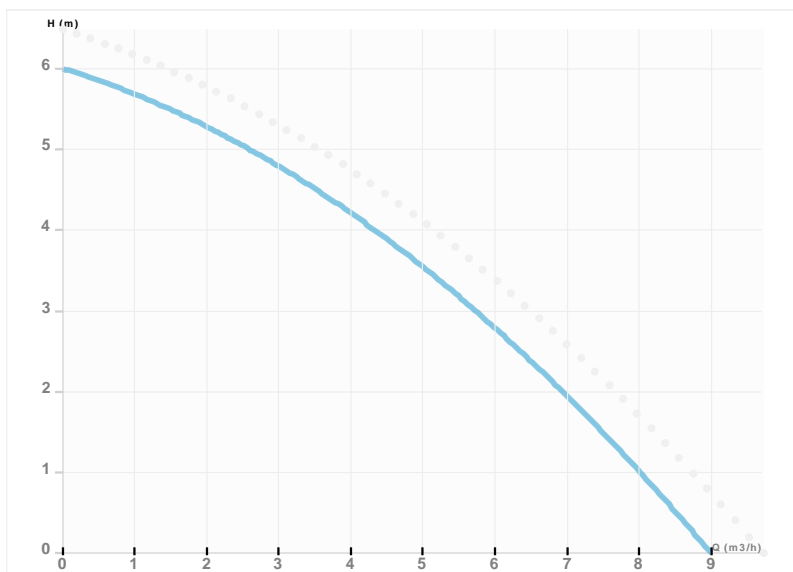

NMT SMART 40/60 F

NMT SMART / Electronically regulated circulating pump
 Heating, Climatisation



Part number	979523483
Declared height	PN6/10
Power supply	1 ~ 230V, 50Hz
Declared protection	IP 44 (IEC 144)
Q max	9.0 [m³/h]
H max	6.0 [m]
RPM	3400 [1/min]
Motor power	10-90 [w]
Declared current	0,1-0,75 [A]
Fluid temperature	2.0 ÷ 110.0 [°C]
Insulation class	H
Casing construction	Single casing
DN1	32 [mm]
DN2	32 [mm]
Casing material	Gray cast iron
Connector	PN6/10
Weight	8,5 [kg]
Connectors position	Inline (0°)
Length	220 [mm]

Drawing

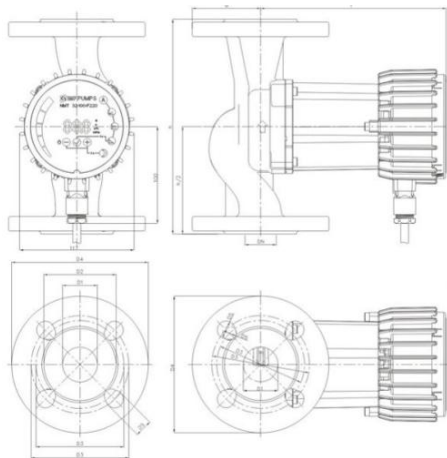

DN=40 h=220 a=75 l=190

Sketch

