

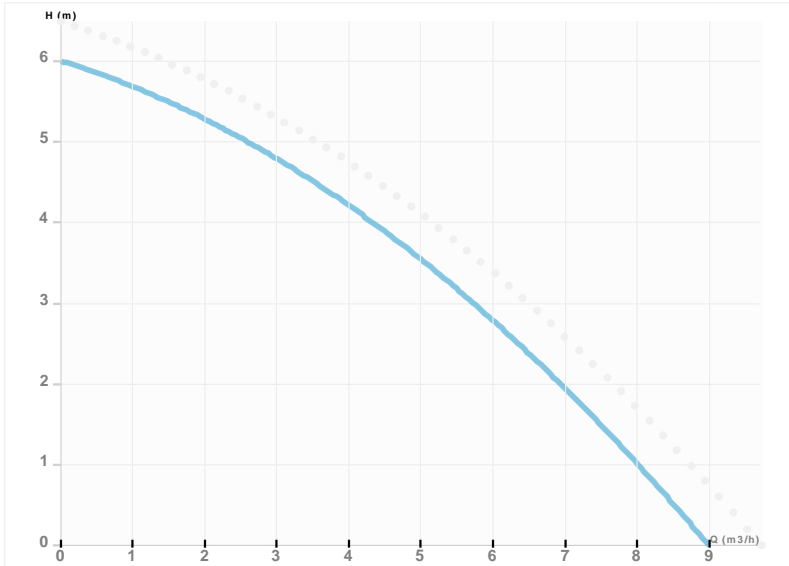

## NMT SAN SMART 32/60-180

NMT SAN SMART C/ Electronically regulated circulating pump  
 Heating, Climatisation



Part number	<b>979524480</b>
Declared height	<b>PN10</b>
Power supply	<b>1 ~ 230V, 50Hz</b>
Declared protection	<b>IP 44 (IEC 144)</b>
Q max	<b>9.37 [m³/h]</b>
H max	<b>5.92 [m]</b>
RPM	<b>3400 [1/min]</b>
Motor power	<b>90.0 [w]</b>
Declared current	<b>0.1 [A]</b>
Fluid temperature	<b>2.0 ÷ 110.0 [°C]</b>
Insulation class	<b>F</b>
Casing construction	<b>Single casing</b>
DN1	<b>32 [mm]</b>
DN2	<b>32 [mm]</b>
Casing material	<b>Bronze</b>
Connector	<b>1 1/4"</b>
Weight	<b>0 [kg]</b>
Connectors position	<b>Inline (0°)</b>
Length	<b>180 [mm]</b>

Drawing

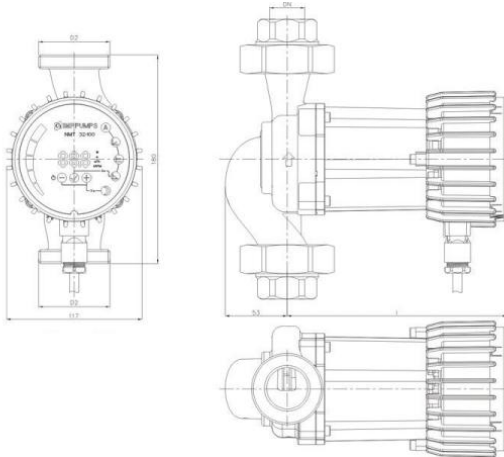

Sketch

