

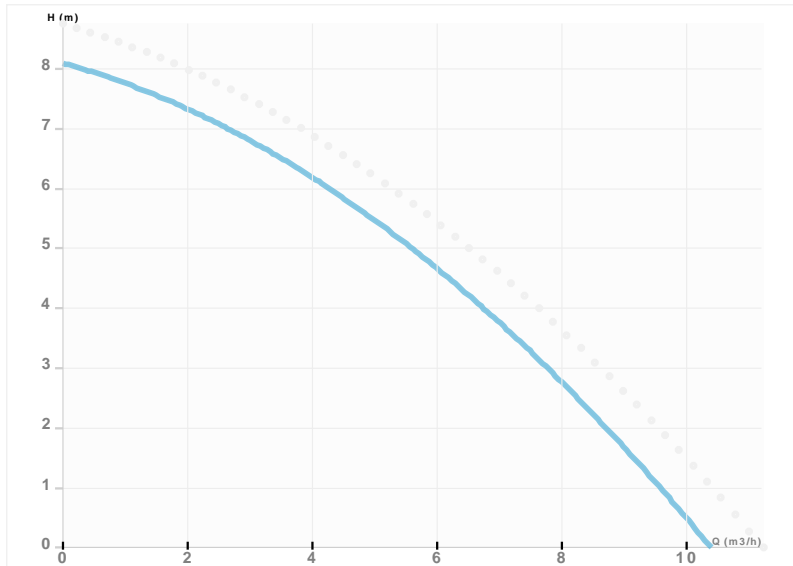

NMT SAN SMART 25/80-180

NMT SAN SMART C/ Electronically regulated circulating pump
 Heating, Climatisation



Part number	979524529
Declared height	PN10
Power supply	1 ~ 230V, 50Hz
Declared protection	IP 44 (IEC 144)
Q max	10.63 [m³/h]
H max	8.23 [m]
RPM	4000 [1/min]
Motor power	140.0 [w]
Declared current	0.1 [A]
Fluid temperature	2.0 ÷ 110.0 [°C]
Insulation class	F
Casing construction	Single casing
DN1	25 [mm]
DN2	25 [mm]
Casing material	Bronze
Connector	1"
Weight	0 [kg]
Connectors position	Inline (0°)
Length	180 [mm]

Drawing

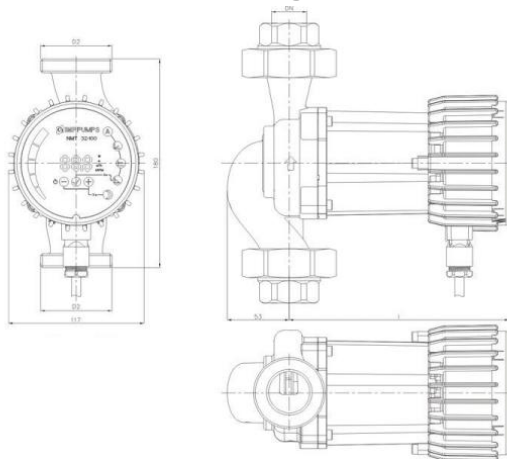

Sketch

