

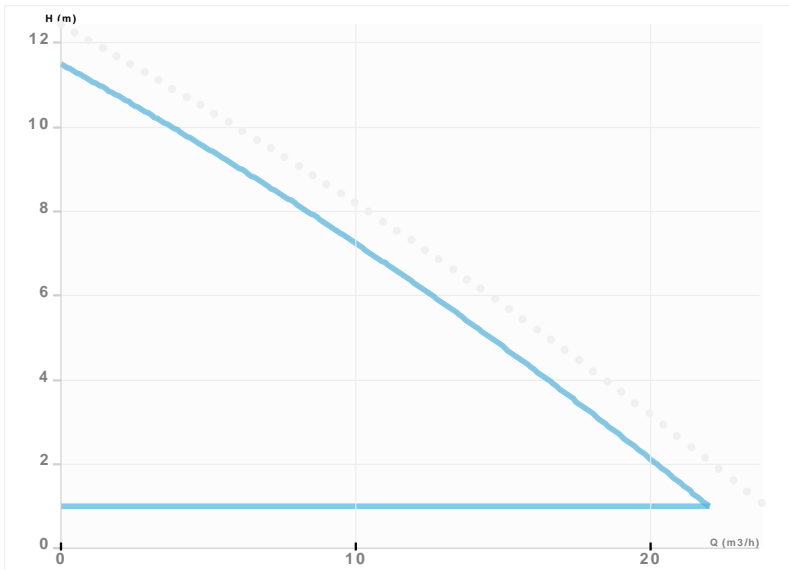

NMT SAN LAN C 40F

NMT SAN LAN C / Electronically regulated threaded pumps for circulation of sanitary water - communication
 Sanitary water



Part number	979523609
Declared height	PN6/10
Power supply	1 ~ 230V, 50Hz
Declared protection	IP 44 (IEC 144)
Q max	25.0 [m³/h]
H max	13.0 [m]
RPM	3000 [1/min]
Motor power	20-500 [w]
Declared current	2,2 [A]
Fluid temperature	5.0 ÷ 65.0 [°C]
Insulation class	H
Casing construction	Single casing
DN1	40 [mm]
DN2	40 [mm]
Casing material	Bronze
Connector	PN6/10
Weight	27 [kg]
Connectors position	Inline (0°)
Lenght	250 [mm]

Drawing

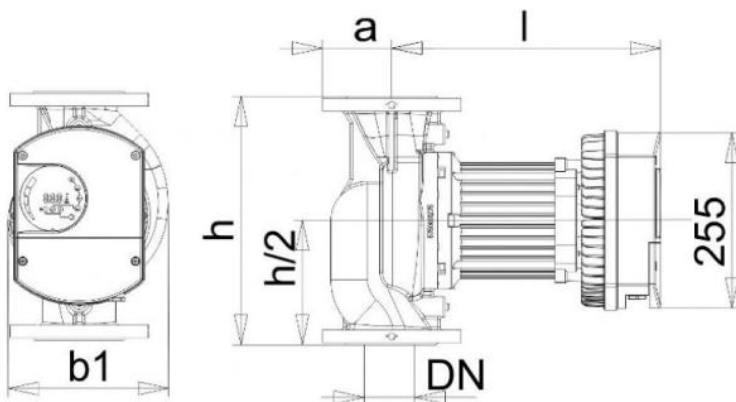

DN=40 b1=198 l=321 h=250 a=65 holes=4

Sketch

