

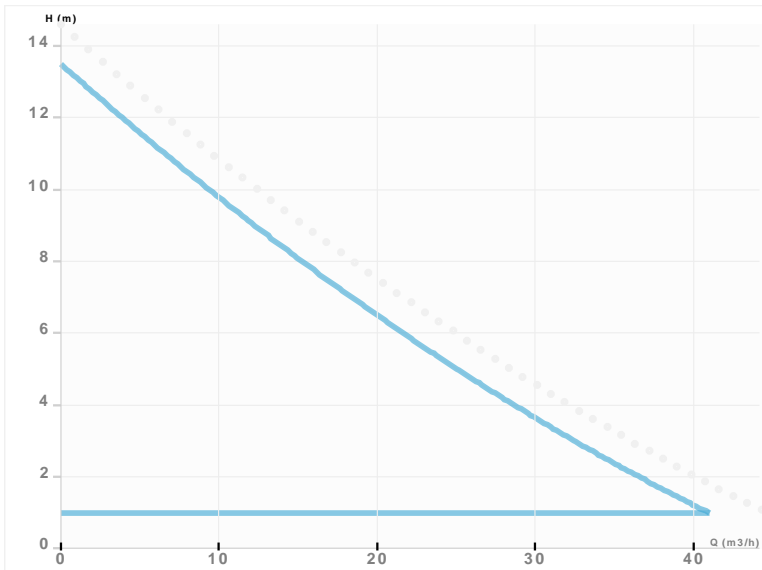

NMT SAN LAN 50F

NMT SAN LAN / Electronically regulated threaded pumps for circulation of sanitary water
 Sanitary water



Part number	979523607
Declared height	PN6/10
Power supply	1 ~ 230V, 50Hz
Declared protection	IP 44 (IEC 144)
Q max	39.0 [m³/h]
H max	13.0 [m]
RPM	3000 [1/min]
Motor power	26-800 [w]
Declared current	3,5 [A]
Fluid temperature	5.0 ÷ 65.0 [°C]
Insulation class	H
Casing construction	Single casing
DN1	50 [mm]
DN2	50 [mm]
Casing material	Bronze
Connector	PN6/10
Weight	33 [kg]
Connectors position	Inline (0°)
Lenght	280 [mm]

Drawing

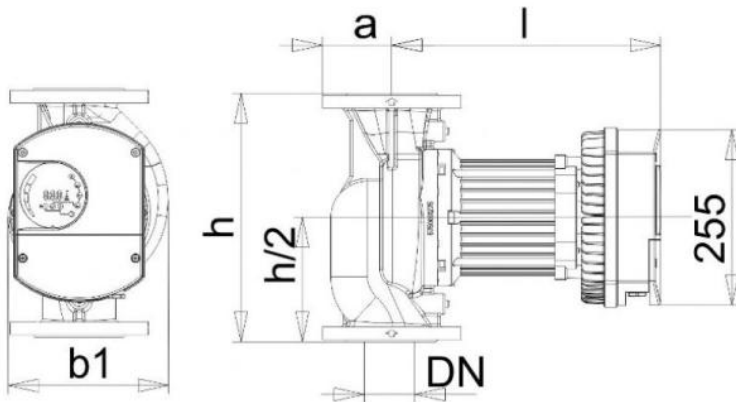

DN=50 b1=200 l=355 h=280 a=70 holes=4

Sketch

