

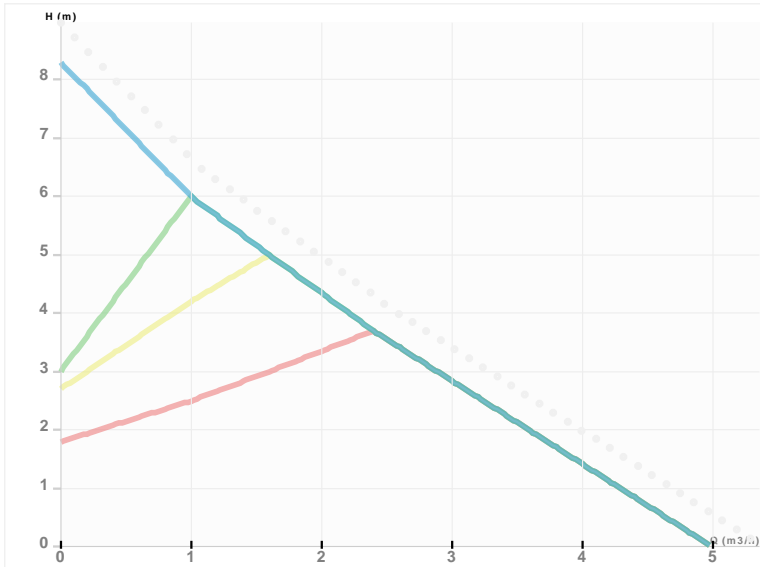

NMT PLUS ER 25/80 - 130

NMT PLUS ER / Electronically regulated circulating pump with external control
 Heating, Climatisation



Part number	979523157
Declared height	PN10
Power supply	1 ~ 230V, 50Hz
Declared protection	IP 44 (IEC 144)
Q max	3.7 [m³/h]
H max	6.0 [m]
RPM	3940 [1/min]
Motor power	75 [w]
Declared current	0,05-0,6 [A]
Fluid temperature	-10.0 ÷ 110.0 [°C]
Insulation class	H
Casing construction	Single casing
DN1	25 [mm]
DN2	25 [mm]
Casing material	Gray cast iron
Connector	1"
Weight	2,1 [kg]
Connectors position	Inline (0°)
Length	130 [mm]

Drawing

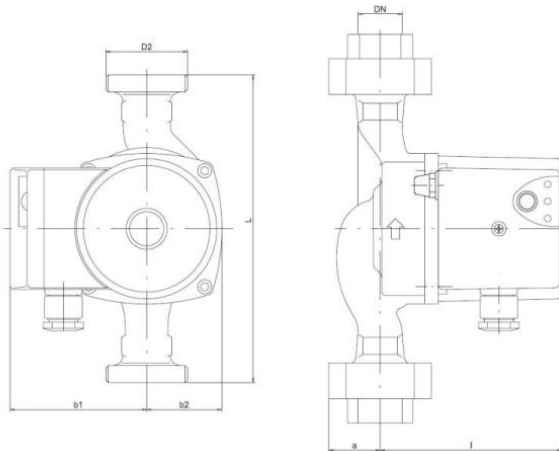

L=130 DN=25 b1=80 b2=48 l=108 a=32 D2=6/4"

Sketch

