

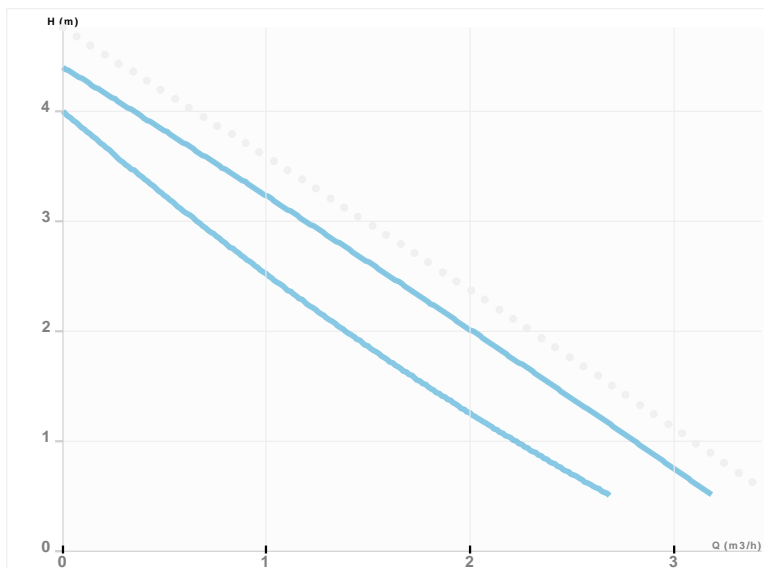

GHN SOL 25/40-180

GHN SOL / Threaded circulation pumps for solar systems
 Heating, Climatisation, Solar systems



Part number	979521358
Declared height	PN10
Power supply	1 ~ 230V, 50Hz
Declared protection	IP 44 (IEC 144)
Q max	3.0 [m³/h]
H max	4.0 [m]
RPM	1630 - 2456 [1/min]
Motor power	75 [w]
Declared current	0,25 - 0,33 [A]
Fluid temperature	-10.0 ÷ 110.0 [°C]
Insulation class	H
Casing construction	Single casing
DN1	25 [mm]
DN2	25 [mm]
Casing material	Gray cast iron
Connector	G 1 1/2"
Weight	2,6 [kg]
Connectors position	Inline (0°)
Length	180 [mm]

Drawing

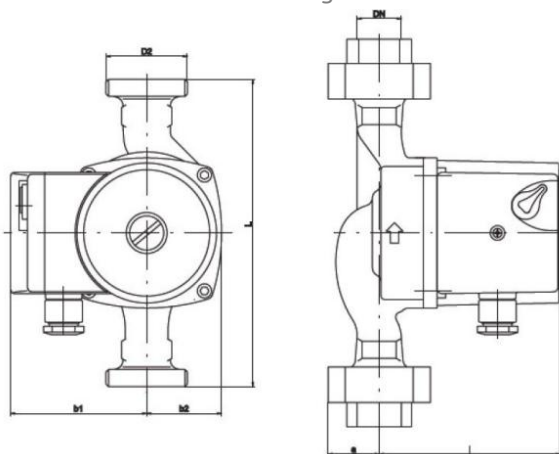

DN=25 D2=1 1/2" L=180 l=108 b1=80 b2=44 a=32

Sketch

